

# Sungale



CD803

## *Digital Photo Frame User's Manual*



For ongoing product improvement, this manual is subject to modification without prior notice.

## User Notice

---

This product has met electronic emissions standards required. It can be used safely at home.



## Contents

---

### Before Operation

---

Product Introduction	2
Safety Precautions	3
Package Contents	5
Photo Frame Overview	6

### Basic Operation

---

Remote Control	8
Power Connection	10
Insert a memory card	11
Photos	12
Music	13
Photos+Music	15
Movie	16
E-Book	17

### Advanced Operation

---

Edit files	18
Settings	21
Calendar	22
Clock	23
Alarm	24
Connect PC	25

### Customer Management

---

Question&Answer	26
Troubleshooting	27
Specifications	28

# **Before Operation**

---

## **Product Introduction**

---

Our Digital Photo Frame is a convenient image frame that keeps your favorite images at your fingertips.

With its bright and vivid LCD screen, the Digital Photo Frame eliminates the need for tedious photo printing and injects a new level of convenience into your life.

With its diverse file management functions, this Digital Photo Frame allows you to relive wonderful memories anytime.

You can use the Digital Photo Frame to enjoy memories by presenting them with refined images.

# Before Operations

## Safety Precautions

Please read the following guidelines carefully to ensure user safety.

### Power Precautions

- ⚠ WARNING:** indicates information that, if neglected, could result in serious injury and/or death to the user.
- ⚠ CAUTION:** indicates information that, if neglected, could result injury to the user and/or material damage.

**01. Use only the authorized power supply product.** Failure to do so could result in product malfunction.



**02. When connecting the power source, make sure that your hands are free of moisture.** Failure to do so could result in electrical shock.

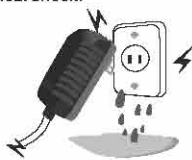

**03. Make sure that the power supply is firmly plugged in and not loose.** Failure to do so could result in electrical shock.

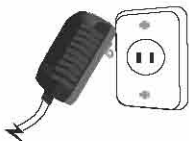

**04. Do not let the power cord get overly entangled and do not place any heavy objects on the cord.** Failure to do so could result in electrical shock.



**05. Do not connect the power supply to an electrical power strip with other various connections.** Failure to do so could result in fire.

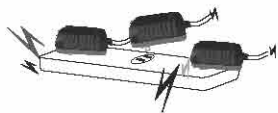

**06. Disconnect the power supply during inclement weather conditions that include thunder and lightning.** Failure to do so could result in fire.



# Before Operations

## Safety Precautions

Please read the following guidelines carefully to ensure user safety and avoid malfunction.

### Product Related Precautions

01. Dropping the product or subjecting it to a significant impact can cause critical damage.

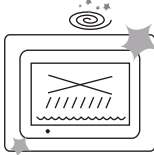

02. Spilling water or any other liquid on the product can cause critical damage.



03. Striking or scratching the LCD screen may cause critical damage.

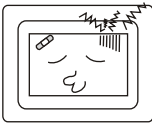

04. When cleaning the LCD screen, turn off the power and wipe it gently with a soft cloth.

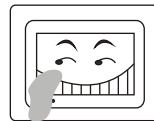

05. Do not subject the product to severe humidity and/or heat.

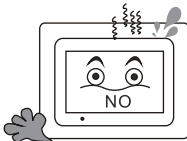

06. Make sure to power off the unit before disconnecting the power supply.

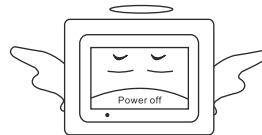

# Before Operations

---

## Package Contents

---

For the improvement of product performance and/or quality, the basic components may be modified without prior notice. The components may differ slightly in appearance with the provided images.

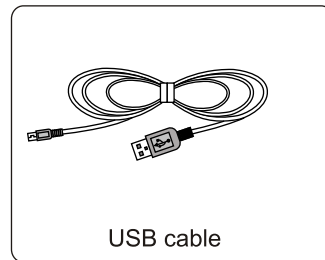
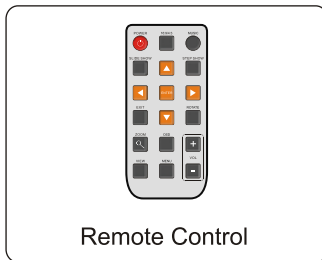
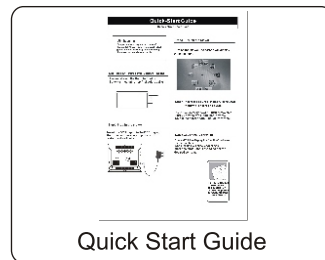
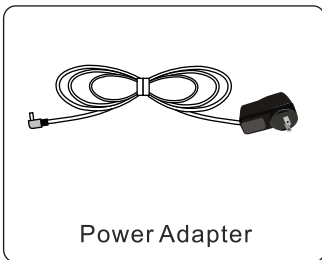
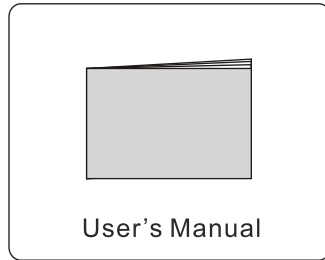
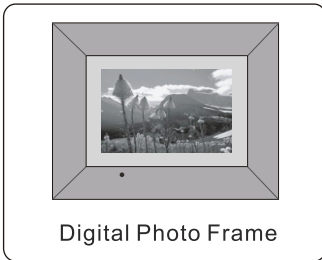

# Before Operations

## Photo Frame Overview

The package contents may differ slightly in appearance with the provided images

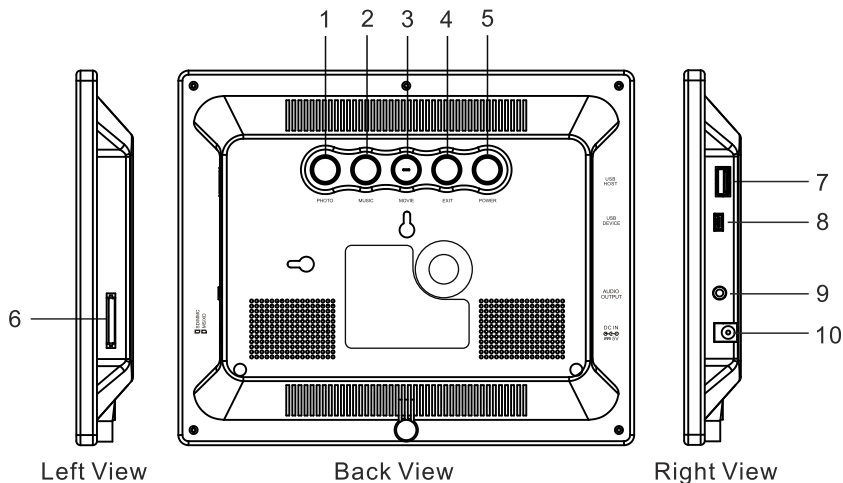

### Back View

1. **PHOTO:** Press the button to enter into the photo slide show.
2. **MUSIC:** Press the button to play music.
3. **MOVIE:** Press the button to play movie.
4. **EXIT:** Stop the current action and return to the previous menu.
5. **POWER:** Turn the player off and on .

### Left View

6. **MS/SD/MMC/XD CARD SLOT:** Insert supported memory card types here.

### Right View

7. **USB HOST :** Connect the USB cable from the DPF player to USB removable storage device / Mobile hard disk.
8. **USB DEVICE:** Connect the photo frame to PC.
9. **Audio output**
10. **DC IN :** Insert the DC power adapter to the frame.

# Before Operations

---

## Photo Frame Overview

---

- 11. Wall mountable hole.
- 12. Stand: Using the stand provided you can position the photo frame with horizontal or vertical view.
- 13. Speaker: Built in stereo speakers.

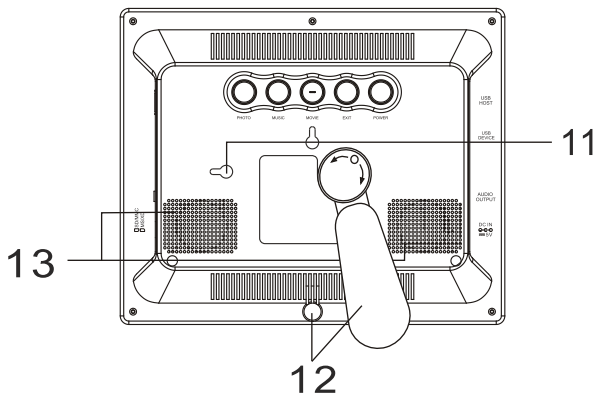

**Back View**



## Basic Operations

---

### Remote Control

---



#### **Power:**

Press **POWER** to turn the player on and off.

#### **16:9/4:3**

Press this button to switch the picture ratio between original and optimal.

#### **Music:**

press **MUSIC** to play songs.

#### **Slide Show:**

Press **SLIDE SHOW** to continually cycle through all of the pictures in the device.

#### **Step Show:**

Press **STEP SHOW** to display a single picture; each press will advance one picture at a time.

**Note:** Remove Insulating Tab to activate battery.

# Basic Operations

---

## Remote Control

---

### Navigation Buttons:

Press the arrow keys to move the cursor to the desired icon.

### Enter:

press **ENTER** to enter/confirm.

### EXIT:

Press **EXIT** to pause or return to the previous menu.

### ROTATE:

Press **ROTATE** to rotate the picture. These operation is available when a picture is playing normally.

### ZOOM:

Press **ZOOM** repeatedly to zoom out /in the picture.

### OSD:

Press **OSD** to display the state of the playing file.

### VIEW:

Press **VIEW** to view the photos in thumbnail mode. Use the up /down/left/right buttons to select the picture and press enter to confirm .

### MENU:

Press **MENU** to return to the main menu.

### VOL+/-:

Press the **VOLUME** button to adjust the player's volume.

# Basic Operations

## Power Connection

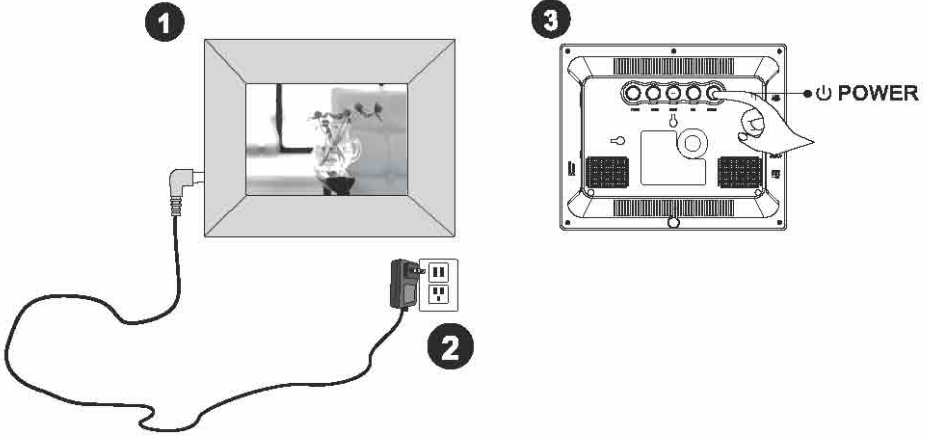

1. Connect the power adaptor to the DC IN jack on the left side of the frame.
2. Plug in the power cord.
3. The frame will automatically power on.

# Basic Operations

---

## Insert a memory card

---

SD, MS, MMC, XD cards are compatible with this unit.

1. Insert the memory card according to the indication of icon beside the slot.
2. Misaligning may cause artificial damage. This may nullify the warranty.

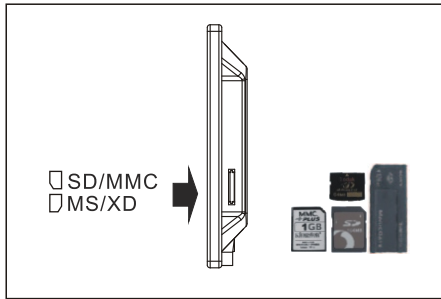

## USB Removable Storage Devices

Insert USB removable storage devices (ie: flash drives) into the USB HOST port on the side of the frame.

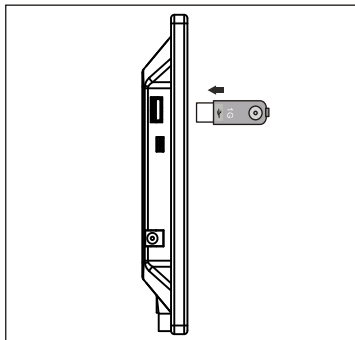

## Removing the Memory Card

Pull the card straightly out of the unit and avoid bending the card.

# Basic Operations

---

## PHOTO

---

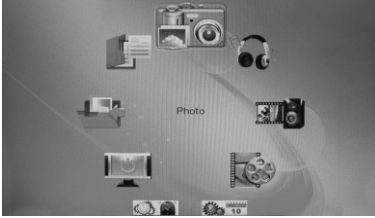

### Slide Show Mode

Tip 1: Press the shortcut button PHOTO on the back of the unit to display images in slide show mode.

Tip 2: Press SLIDE SHOW button on the remote control to display images in slide show mode.

Tip 3: In the main menu, use the navigation buttons on the remote control to select the PHOTO menu, press ENTER button to display images in slide show mode.

Tip 4: In thumbnail mode, select the Slide Show icon and press ENTER button to begin slide show.

### Step Show Mode

Tip 1: In slide show mode, press STEP SHOW button on the remote control to change into the step show mode.

Tip 2: In the main menu, press STEP SHOW button on the remote control to enter into the step show mode.

Tip 3: In thumbnail mode, use the navigation buttons to select photos, press ENTER button to display the desired photo.

Note: The SLIDE SHOW and STEP SHOW buttons on the remote control will be invalid in thumbnail mode.

# Basic Operations

## Photos

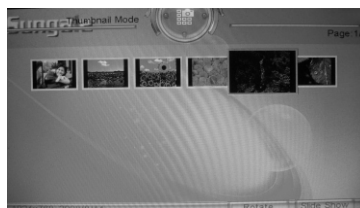

### Thumbnail Mode

Tip 1: In slide show mode, press EXIT button to enter into the thumbnail mode.

Tip 2: in slide show or step show mode, press the View button to view the photos in thumbnail mode.

Use the navigation buttons to select photos, press the ▼ button to activate the Rotate icon in the right bottom. Continue to press the ► button to activate the Slide Show icon .

### Rotate a photo

Tip 1: In slide show or step show mode, press the ROTATE button on the remote control to rotate the displaying photo for 90° at each operation.

Tip 2: In thumbnail mode, activate the Rotate icon, and press ENTER button to rotate the desired photo.

**Note:** When rotating a photo in thumbnail mode:

1. The Rotate icon will be changed into the Reset icon automatically, press the Reset icon to reset the photos.
2. The Slide Show icon will be changed into the Return icon, press the Return icon to return to previous mode.

### Zoom in/out a photo

Press the ZOOM button repeatedly to zoom in or zoom out the desired photo.

# Basic Operations

## Music

### Play music

Tip 1: Press the shortcut button MUSIC on the back of the unit to enter the music file list and play music .

Tip 2: In the main menu, use the navigation buttons to select the MUSIC menu, and press ENTER button to enter the music file list and play music.

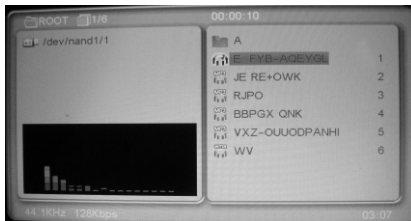

### Selecting a song

Use the navigation buttons to select desired folder and desired song, press the ENTER button to play.

### Adjusting the volume

Use the VOL "+" and "-" buttons to increase or decrease the volume during music playing back



### Exit

Press Exit button to return to the previous menu.

# Basic Operations

---

## Photo+Music

---

Tip 1: In the main menu mode, use the navigation buttons to select the Photo+Music icon, press ENTER button to slide show photos in music background.

Tip 2: In the slide show mode, press the shortcut button MUSIC on the back of the unit to display images in music background.

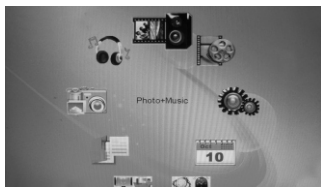

### Mute the sound

When slide show images in music background, press the MUSIC button to mute the sound. Press this MUSIC button once again to continue displaying images in music background.

### Adjust the volume

When slide show images in music background, use the VOL "+" or "-" buttons to increase or decrease the volume.

### Exit

During play back, press the Exit button to return to the main menu.



# Basic Operations

---

## Movie

---

### Play movie

Tip 1: Press the shortcut button MOVIE on the back of the unit to play movie.

Tip 2: In the main menu, use the navigation buttons to select the MOVIE menu, and press ENTER button to play movie.

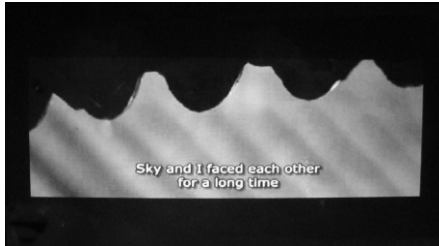

### Selecting a movie file

1. During movie playing back, press EXIT button to enter the movie file list.
2. Use the navigation button to select desired folder and desired movie file.
3. Press the ENTER button to play.

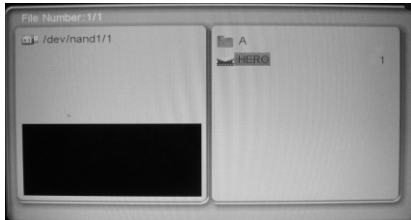
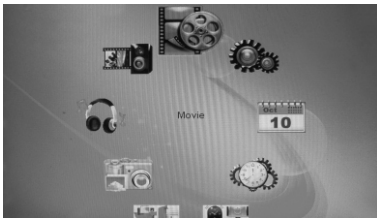

### Adjusting the volume

Use the VOL “+” and “-” buttons to increase or decrease the volume during movie playing back

### Exit

Press Exit button to return to the previous menu.

# Basic Operations

## E-Book

In the main menu, use the navigation buttons to select the E-Book menu, and press ENTER button to enter the file list.

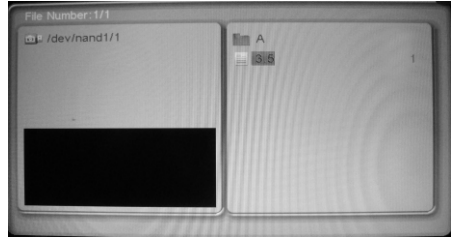
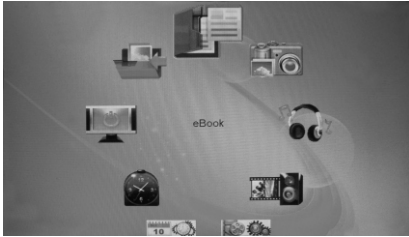

### Read a text

In the E-Book file list, use the navigation buttons to select the desired text, and press ENTER button to read the contents.

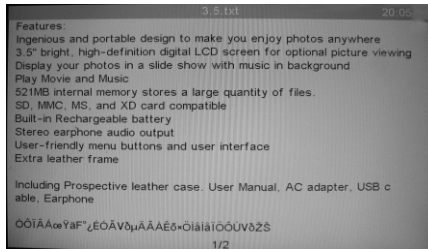

### Previous/ Next row

When reading a text, press the ▲ or ▼ to skip to the previous or next row.

### Previous/ Next Page

When reading a text, press the ◀ or ▶ to skip to the previous or next page.

### Exit

Press Exit button to return to the previous menu after reading.

# Advanced Operations

## Edit files

In the main menu, use the navigation buttons to select the Edit menu and press ENTER button, the screen will display as below:

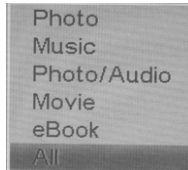

Select desired icon, press ENTER button and use the navigation buttons to activate edit files.

After highlighting the Edit icon, press ENTER button, the screen will display as below:

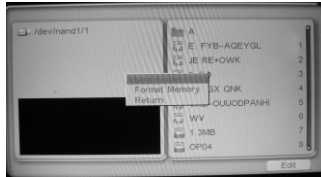

### Create a new folder

Use the navigation buttons to select the New Folder icon, press ENTER button, you will see the following screen:

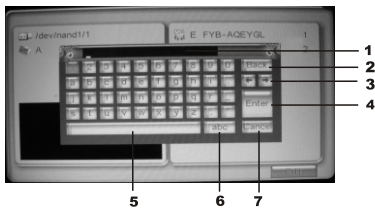

ICONS	MEANING
1	Input field
2	Back to delete
3	Remove the cursor to left/right
4	Confirm and exit
5	Space bar
6	Input solution
7	Give up the operation

Use the soft-keyboard to name the new folder.

# Advanced Operations

## Edit files

### Format Memory

Activate the Edit icon, use the navigation buttons to select the Format Memory icon to format the memory.

### Copy files

In the file list, select the file you want to copy and press ENTER button to confirm the operation. To copy more, continue selecting files. The confirmed files will be in a yellow frame.

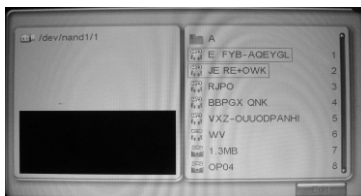

Use the navigation buttons to activate the Edit icon, the screen will display as below:

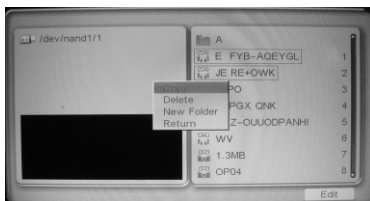

Use the navigation buttons to select the Copy icon, press enter to confirm the operation.

### Paste files

In the file list, select the desired storage device or folder, and then activate the Edit icon. The screen will display as below:

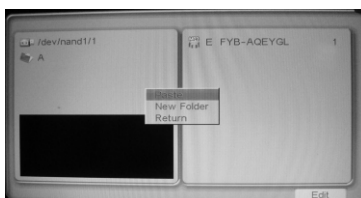

# Advanced Operations

## Edit files

Select the Paste icon and press ENTER button to confirm. If there is a file in the list under the same name, you will see the following screen:

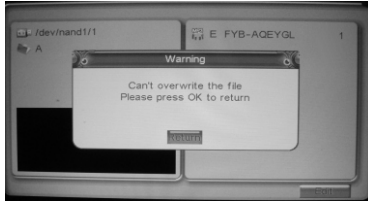

If the pasted files are new files for the list, the screen will display as below:

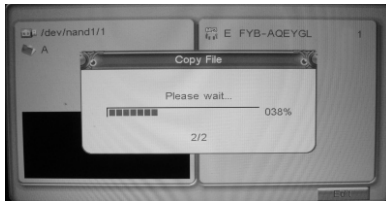

## Delete files

Use the navigation buttons to select the Edit icon, press ENTER button, the screen will display as right below:

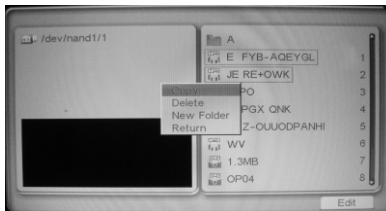

Use the navigation buttons to select the Delete icon, press ENTER button. There will be a tip in the screen. Select the Yes icon to confirm the operation, and select the No icon to give up the operation.

# Advanced Operations

## Settings

In the main menu, use the navigation buttons to select the Setup menu, press ENTER button to enter into the Setup Menu mode.



### Photo Setting

Use the navigation buttons to select the Photo Setting icon, and set the interval time, the transition effect and browse mode.

### Auto-play

Use the navigation buttons to select the Auto-play icon, you can set Photo/ Music/ Movie auto-play on or off.

### Display Setup

Use the navigation buttons to select the Display Setup icon, you can adjust the Brightness, the Contrast, the TFT Brightness, the TFT Contrast, and the TFT Saturation.

### Custom Setup

Use the navigation buttons to select the Custom Setup icon, you can select the OSD Language, the Repeat Mode, different source, and default mode in the menu.

### Exit

Use the navigation buttons to select the Exit icon, and press ENTER button to return to the main menu.

# Advanced Operations

## Calendar

In the main menu, use the navigation buttons to select the Calendar menu, press ENTER button to enter into the calendar setting mode.



### Display Calendar

Use the navigation buttons to select the Display icon, press ENTER button to confirm. The screen will display as below:

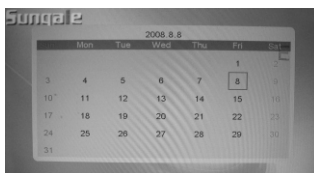

### Set Date

Use the navigation buttons to select the Set Date icon, press ENTER button to confirm. The screen will display as below:

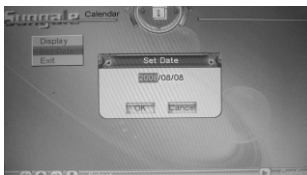

Use the navigation buttons to set the right date, activate the OK icon to save the operation, and activate the Cancel icon to give up the operation.

### Exit

In the calendar setting mode, use the navigation buttons to select the Exit icon, press ENTER button to return to the main menu.

# Advanced Operations

## Clock

In the main menu, use the navigation buttons to select the **Clock** menu, press **ENTER** button to enter into the clock setting mode.



## Display

In the **Clock Setting** mode, use the navigation buttons to select the **Display** icon, and set the clock displaying in three different mode: clock, analog clock, or clock&calendar.



## Set Time

Use the navigation buttons to select the **Set Time** icon, press **ENTER** button to confirm. The screen will display as below:



Use the navigation buttons to set the right time, activate the **OK** icon to save the operation, and activate the **Cancel** icon to give up the operation.

## Exit

In the clock setting mode, use the navigation buttons to select the **Exit** icon, press **ENTER** button to return to the main menu.



# Advanced Operations

---

## Alarm

---

In the main menu, use the navigation buttons to select the Alarm menu, press ENTER button to enter into the alarm setting mode.

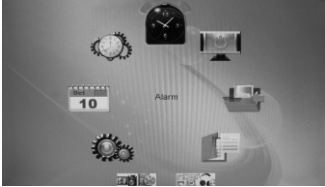

### Enable

Use the navigation buttons to select the Enable icon, and set the alarm on or off.

### Set Time

Use the navigation buttons to set the desired alarm time, activate the OK icon to save the operation, and activate the Cancel icon to give up the operation.

### Exit

Select the Exit icon and press Enter button to return to the main menu.

**Attn:** The alarm works only when the digital photo frame is powered on.

# Advanced Operations

## Connect PC

In the main menu, select the Connect PC menu.



Use the supplied USB cable to connect your DPF to your PC. Then press ENTER button. Don't connect your DPF to the PC when play back.

**Note:** The ASSP is a software in the internal memory developed by Sungale go manage the picture and audio files to optimize the utilization of the source of the memory.

The ASSP is inapplicable to manage ebook and video files. Just use the unit as a regular storage device to manage ebook and video files after connecting the unit to the PC.

### Start ASSP

On your computer, click "My computer", then, click "StorageDevice Disk", then, double click Fileconverter.exe, you will enter into ASSP interface.

- Tip :
1. If your PC has set as auto-run, you will enter into the ASSP interface directly, no operation needed.
  2. The PC installed the anti-virus software or other hold-up software will make the "autorun.inf" invalid. In this situation, the file is set as hidden file. If you want to autorun the ASSP, you can set your PC to display hidden files.

### Use ASSP

1. Click "AddFile", your computer's files and folders will appear, double click the file or photo to add them to your DPF.
2. Hold on "Shift" or "Ctrl", you can download multi files or photos to your DPF.

In this way, the photos downloaded will be stored at 800X600 to suit your DPF's screen and the MP3 files will be transferred into WMA file.

When you finish the operation, safely remove the USB cable from your PC.

Then press EXIT button to return to the main menu.

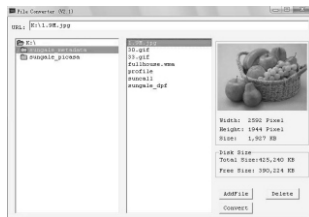

Tip: You also can take the DPF as a regular storage device, select the photos from your computer, then paste them in the DPF's internal memory. In this way, the photos will be stored without compression. If you want to optimize your internal memory, you can select the photos, then click the "Convert".

Attention: Once you format the internal memory of your DPF, the ASSP software will be deleted.

In this situation, you can still use the DPF as a regular storage device, and copy, paste, delete files after connecting your DPF to the PC,

# Customer Management

---

## Question & Answer

---

This chapter will attempt to troubleshoot common problems that one may experience with the Multimedia DPF. If this guide does not solve your problem, do not dismantle the machine yourself.

Question	Answer
What is the main function of the digital photo frame?	Using the digital photo frame, you can display images, play music and movie, and read e-book.
Does Multimedia Digital Photo Frame have built-in memory?	Yes. The player has an internal memory to store media files. Do not rename the memory's name.
What is the best picture resolution displayed on the screen?	The player's best resolution is 800X480.
Why Digital picture Frame does not advance to next picture?	<ol style="list-style-type: none"><li>1. There is only one picture in the frame.</li><li>2. You are viewing high -resolution pictures on the card, High-resolution pictures can take longer time to display.</li><li>3. You are in STEP SHOW display mode.</li><li>4. The next picture is damaged.</li></ol>
How can I see the file list?	Please set Browse item under Menu-Photo Setting to File Manger.
What memory cards are compatible with the digital frame?	Secure Digital Card (SD)/MultiMedia Card (MMC)/XD/ Memory Stick.
Where to get ebooks?	Click <a href="http://www.sungale.com">www.sungale.com</a> and find FAQs, there are a list about where to get ebooks. Make sure download ebooks in TXT format.
How to convert PDF or HTML into TXT files?	Click <a href="http://www.sungale.com">www.sungale.com</a> and find FAQs, there are methods to convert PDF or HTML into TXT files.
What is the ASSP software?	The ASSP is a software in the internal memory to manage the picture and audio files to optimize the utilization of the source of the memory. It is inapplicable to manage ebook and video files.
How to put the ebook or video files into the memory?	Just use the unit as a regular storage device, copy and paste the files from the PC to the internal memory.

## Troubleshooting

---

Some simple checks or a minor adjustment eliminate common problems:

### No power

1. Check if the power button is on.
2. Check if the power outlet is operational.
3. Check if the power cord is damaged.
4. Check if the power plug is connected to photo frame properly.

### Can not read the card

1. Check if the cord is damaged.
2. Check if the card is connected the photo frame correctly.
3. Pull out the card, and then insert again.

### Photo Frame is not working

Turn off the power, and then turn it on again.

### The Remote Control is not working

1. Check if the battery is properly installed.
2. Check if the battery “protective plastic” is pulled out.

# Customer Management

---

## Specifications

---

Display: 8" TFT LCD Digital Screen

Resolution: 800(RGB) X 480 (Pixels) (16:9)

Power: AC Adapter, Input 110-220V; Output 5V, 1A

### **Environmental operating ranges**

Operation: 32~95 F, Humidity 0~85%

Storage: -4~140 F, Humidity 10~90%

**Note:** All data are provided for reference purposes only. Sungale reserves the right to make any changes without prior notice.

The numbers of photos, songs and movies to be stored to the Onboard Memory will vary due to the size of the file being saved.

# **FCC and Safety Information**

---

## **• FCC Part 15.19**

This device complies with Part 15 of the FCC Rules .Operation is subject to the following two conditions: (1) this device may not cause harmful interference , and (2) this device must accept any interference received ,including interference that may cause undesired operation .

## **• FCC part 15.21**

Warning: Changes or modifications to this unit not expressly approved by the party responsible for compliance could void the user's authority to operate the equipment.

## **• FCC part 15.105**

Note : This equipment has been tested and found to comply with the limits for a Class B digital device ,pursuant to Part 15 of the FCC Rules, These limits are designed to provide reasonable protection against harmful interference in a residential installation .This equipment generates, uses, and can radiate radio frequency energy and ,if not installed and used in accordance with the instructions, may cause harmful interference will not occur in a particular installation .If this equipment does cause harmful interference to radio or television reception ,which can be determined by turning the equipment off and on ,the user is encouraged to correct the interference by one or more of the following measures:

- Reorient or relocate the receiving antenna.
- Increase the separation between the equipment and receiver.
- Connect the equipment into an outlet on circuit different form that to which the receiver is connected.
- Consult the dealer or an experienced radio TV technician for help.

# LIMITED WARRANTY

The limited warranty set forth below is given by the manufacturer with respect to Sungale brand DPF players and other consumer electronics products purchased and used in the United States of America. The manufacturer warrants this product against defects in material or workmanship as follows:

**LABOR:** For a period of ninety (90) days from the date of purchase if this Product is defective, the manufacturer will repair or replace the Product, at its option, at no charge. After this ninety (90) days period up to one year, a labor charge of US\$30.00 will be charged for each service.

**PARTS:** For a period of one year from the date of purchase, the manufacturer will supply, at no charge, new or rebuilt replacement parts in exchange for defective parts. After this one year period, the manufacturer will charge the new or replacement parts.

This warranty does not cover: (1) customer instruction, installation or set up; (2) cosmetic damage or damage due to accident, misuse, abuse, or negligence; (3) commercial use of the Product; (4) modification of any part of the Product; (5) damage due to improper operation, improper maintenance, or connection to an improper voltage supply; (6) damage due to an attempted repair of the Product by anyone other than a facility authorized by the manufacturer to service the Product; (7) consumables (such as fuses and batteries). This warranty is valid only in the United States.

The product must be accompanied by a copy of the original retail purchase receipt. If no proof of purchase is attached, the warranty will not be honored and repair cost will be charged.

This warranty is valid with attach written documentation detailing the complaint to the outside or inside of the carton.

This warranty is invalid if the factory applied serial number has been altered or removed from the Product.

The manufacturer reserves the right to modify any design of this product without prior notice.

To obtain warranty service, you must deliver the product freight prepaid, in either its original packaging or packaging affording an equal degree of protection, plus proof of purchase, to:

**Service Center**  
13941 Central Ave,  
Chino, CA 91710  
Tel: **800-473-5156**

REPAIR OR REPLACEMENT AS PROVIDED UNDER THIS WARRANTY IS THE EXCLUSIVE REMEDY OF THE CONSUMER. THE SERVICE CENTER SHALL NOT BE LIABLE FOR ANY INCIDENTAL OR CONSEQUENTIAL DAMAGES FOR BREACH OF ANY EXPRESS OR IMPLIED WARRANTY ON THIS PRODUCT. EXCEPT TO THE EXTENT PROHIBITED BY APPLICABLE LAW, ANY IMPLIED WARRANTY OF MERCHANTABILITY OR FITNESS FOR A PARTICULAR PURPOSE ON THIS PRODUCT IS LIMITED IN DURATION TO THE DURATION OF THIS WARRANTY.

Some states do not allow the exclusion or limitation of incidental or consequential damages, or allow limitations on how long an implied warranty lasts, so the above limitations or exclusions may not apply to you. This warranty gives you specific legal rights, and you may have other rights which vary from state to state.

Digital Photo Frame

**Sungale**